



INSTALLATION MANUAL

L.MAS.10.C.M

NISSAN NV400 (2010-ONWARDS)

X62, FWD

OPEL / VAUXHALL MOVANO (2010-ONWARDS)

X62, SINGLE TIRES, FWD

RENAULT MASTER (2010-ONWARDS)

X62, FWD





Contents

1	Foreword	4
2	Introduction	5
3	Very important notes	6
4	Overview	7
5	Instructions for installation	8
5.1	Recommended Tightening Torque	8
5.2	Preparation	8
5.3	Installation of the Air Suspension at Right Side	9
5.4	Installation of the Air Suspension at the Left Side	9
5.5	Fitting of Inflator Console	10
5.6	Tube Connection and Disconnection, Cutting and Routing	12
5.7	Bellow Inflation	13
5.8	Spring Alignment	14
5.9	Maintenance	14
5.10	Check List	15
6	Installation pictures	16
7	Epilogue	19



1 Foreword

This manual provides instructions for the installation of an auxiliary air suspension kit, developed specifically for the **Nissan NV400 X62, FWD (2010-onwards)**, **Opel / Vauxhall Movano X62, single tires, FWD (2010-onwards)** and **Renault Master X62 FWD (2010-onwards)**.

To ensure correct installation of the kit, it is strongly recommended that these instructions are read thoroughly before commencing any installation work. Installation should only be carried out by a suitably qualified mechanic or specialist installation facility. DSC Nederland will not accept any responsibility for faults or defects arising from incorrect installation, which automatically renders the guarantee invalid.

IMPORTANT: Manufacturer's Declaration Form

A manufacturer's declaration form is provided with your kit. Following installation of the kit please ensure that this form is completed, signed by a qualified fitter and a copy is returned to DSC Nederland by post, fax or e-mail. Our e-mail address is: info@dscsystems.nl



2 Introduction

THANK YOU FOR CHOOSING AN AUXILIARY AIR SUSPENSION KIT FROM THE RANGE OFFERED BY DSC NEDERLAND. AUXILIARY AIR SUSPENSION IS FITTED IN TANDEM WITH THE STANDARD STEEL SPRINGS OF THE VEHICLE SUSPENSION, AND PROVIDES ENHANCEMENTS IN TERMS OF BOTH THE STABILITY OF THE VEHICLE AND THE COMFORT OF THE PASSENGER.

VEHICLE LEVELLING

Simply by varying the air pressure in the springs, the vehicle can be levelled both front-to-rear and side-to-side. Keeping the vehicle level optimises stability, ensures correct headlamp beam distribution and reduces tyre wear arising from uneven distribution of weight.

STRAIGHT LINE STABILITY

Straight line stability is greatly increased at higher speeds, and when subjected to buffeting from cross-winds or large overtaking vehicles.

REDUCED BODY ROLL

Body roll when cornering or negotiating roundabouts is significantly reduced.

FATIGUE REDUCTION AND WEAR COMPENSATION

Suspension fatigue is reduced, so helping to prevent leaf springs from sagging under repeated or constant loading. Any sagging already present can be compensated-for. This is a particular benefit for motorhomes, which are always fully laden.

RIDE COMFORT

Air springs help to absorb shock loads from uneven road surfaces, therefore general ride quality is much improved.



3 Very important notes

IMPORTANT: Gross Vehicle Weight (GVW)

Air assist kits are not in themselves designed to increase the gross vehicle weight (GVW) rating of a vehicle. They do not legally allow for carriage of a load greater than the carrying capacity stated on the data plate of the vehicle.

Do not exceed the maximum load specified by the vehicle manufacturer.

- to avoid compromising passenger safety
- to prevent possible damage to the vehicle
- for legal reasons

VEHICLE UPRATING

Despite the above words of caution, it is possible to upgrade the weight rating of your vehicle. This must be carried-out by a specialist supplier that will:

- carry out any necessary modifications in addition to fitting the air assist kit
- complete documentation as necessary to inform the Vehicle and Operator Services Agency (VOSA) – a mandatory requirement
- supply and fit a new weight plate to replace the original plate supplied with the vehicle

This process applies to United Kingdom registered vehicles. The process in other countries may be different.

SAFETY GUIDANCE NOTE

The following very useful guidance note is available for free download from the *Health and Safety Executive* (HSE):

PM85, July 2007 *Safe recovery (and repair) of buses and coaches fitted with air suspension.*

The uniform resource locator (URL) for this document is:

<http://www.hse.gov.uk/PUBNS/pm85.pdf>



4 Overview

THE COMPLETE BELLOW AND BRACKET ASSEMBLY ARE SHOWN OF THE RIGHT SIDE BY THE DIAGRAM BELOW.

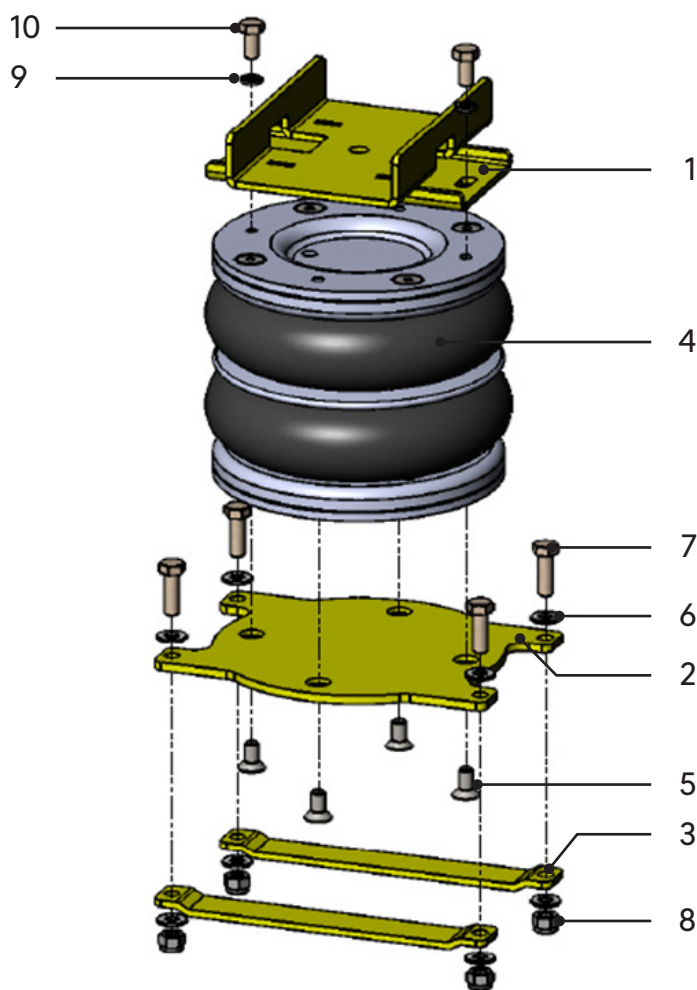

NUMBER	PART NUMBER	DESCRIPTION	QUANTITY
1	65.05.00.1.01	Upper bracket upper part L + R	2
2	65.05.00.1.04.01	Lower bracket upper part L + R	2
3	65.05.00.1.04.02	Strap lower bracket	4
4	OP.LB.170-2.CPL	Air bellow 170/2	2
5	DIN 7991-M8x12	Countersunk screw M8 x 12	8
6	DIN 125A-M8	Washer M8	16
7	DIN 933-M8x25	Hexagon bolt M8 x 25	8
8	DIN 985-M8	Self locking nut M8	8
9	M8	Disc spring washer	4
10	DIN 933-M8x16	Hexagon bolt M8 x 16	4

NOT IN THE ASSEMBLY DRAWING

- The right side
- Tie wraps
- Black and blue hose
- An inflate option
- Declaration of conformity
- Installation manual



5 Instructions for installation



IMPORTANT: Preparation and Precaution

Before beginning installation, ensure that you have sufficient clearance between the axle and the chassis. **Use a jack if necessary.** Install at one side of the vehicle at a time.

Pay attention to your safety at all times during installation - always use **axle stands** to support the vehicle!

The position of the axle stands should be **under the chassis** NOT under the axle!

5.1 RECOMMENDED TIGHTENING TORQUE

During fitting of the air suspension system, it is recommended that nuts and bolts are tightened in accordance with the following table...

TIGHTENING TORQUE IN Nm		
SIZE	CLASS 8.8	CLASS 10.9
M6 x 1.0	11.3	16.5
M8 x 1.25	27.3	40.1
M10 x 1.5	54	79
M12 x 1.75	93	137
M16 x 2.0	230	338

IMPORTANT:

- When both the bolt and nut are made from steel use either class 8.8 or 10.9
- For all other dimensions and tightening torques is left to the skills of a well-trained person

THE FOLLOWING INSTRUCTIONS MAKE REFERENCE TO THE DIAGRAMS ON PAGES 16 TO 18 INCLUSIVE.

5.2 PREPARATION

1. Secure the front wheels, use wheel chocks on both sides of both front wheels.
2. Take the ground terminal from the battery when work to electricity is involved.
3. Lift the rear of the vehicle till there is working space of approximately 15 cm between bump stop and rear axle.



5.3 INSTALLATION OF THE AIR SUSPENSION AT RIGHT SIDE

1. Remove the bump stop. You can easily push the bump stop out of it's holder. The M10 bolt is to be reused for the mounting of the upper bracket (Photo 1,2 & 3).
2. Install the upper bracket with it's original bolt. (Photo 4 & 5). The hole to guide the air hose trough has to be on the inside.
3. Check if the countersunk bolts of the lower bracket are properly tightened.
4. Guide the blue air hose through the hole on the inside and connect it to the air bellow (Photo 6 & 7).
Caution! Don't tighten the special nut of the air line not to tight (See Section 5.6).
5. Bring the air bellow into position on the rear axle and install both M8 bolt with dish washer finger tight at the top side (see Photo 8 & 9).
6. Shift both strap trough the opening of the rebound plate and install the M8 bolts with washers and self locking nuts finger tight till it is still able to shift the air bellow (Photo 10).





5.4 INSTALLATION OF THE AIR SUSPENSION AT THE LEFT SIDE

1. Item 1 till 3 are identical to the right side.
2. Item 4 also, but on the left side we use the black hose.
3. Item 5 and 6 are identical to the right side.
4. Bring the vehicle till driving height (when the vehicle is almost totally empty you have to bring weight into the vehicle). Driving height is app. 13.5 cm ,of course can this height be modified a little on request of the Vehicle owner.
5. Before tightening all bolts and nuts definitely, the air bellow needs to be aligned. See section 5.8.

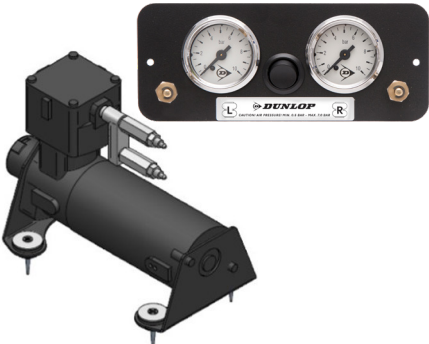
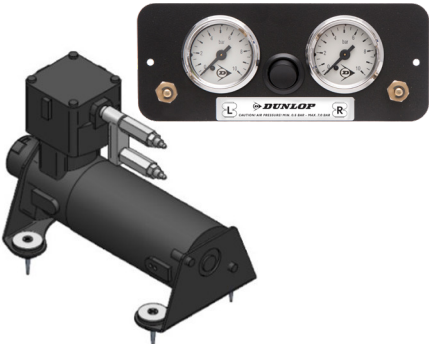

5.5 FITTING OF INFLATOR CONSOLE

Your kit is supplied with one of these inflator options:

	<p>OPTION VALVES</p>	<p>Two valves and a small bracket</p>
	<p>OPTION MANO (WITHOUT CONSOLE)</p>	<p>Two valves and two independent 10-bar pressure gauges</p>
	<p>OPTION 1</p>	<p>Two valves in a console with two independent 10-bar pressure gauges</p>
	<p>OPTION 2</p>	<p>Two valves in a console with two independent 10-bar pressure gauges and a rocker on/off switch to operate the electric motor driven air compressor</p>
	<p>OPTION 3</p>	<p>Four valves (two for raising the vehicle ('UP') and two for lowering the vehicle ('DOWN')) in a console with two independent 10-bar pressure gauges. A pressure switch operates the electric motor driven air compressor to keep the air reservoir of 1.9 litre or 0.5 gallon at pressure</p>

Mount the console in a position of your choice whereby it is firmly fixed, has some protection from the environment (particularly important for the console with gauges) and is easily accessible. Suggested possible locations include.

'STANDARD' CONSOLE

- on the rear bumper
- at the rear beside the license plate
- on the chassis next to a rear wheel
- in a service shutter (motorhomes)
- beside the fuel cap

'OPTION 1', 'OPTION 2' OR 'OPTION 3'

Console...

- in the vehicle cabin, within reach and sight of the driver
- Beside, under the driver seat
- in the wall of a cupboard (motorhomes)
- in a service shutter (motorhomes)

'COMFORT' PACKAGES

The 'OPTION 2' and 'OPTION 3' panels, as shown above, are each part of a Comfort Package that is supplied with a compressor (and also an air reservoir in the case of the 'OPTION 3' panel) for ease of spring inflation and ride height setting. For further information please ask your dealer. The photograph below shows all of the parts of Comfort Package 'OPTION 2' and 'OPTION 3'.



OPTION.2



OPTION.3



5.6 TUBE CONNECTION AND DISCONNECTION, CUTTING AND ROUTING

CONNECTION AND DISCONNECTION

Tubes are connected as shown by the diagrams below:

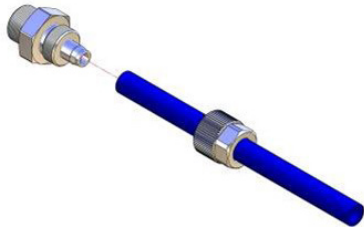

A. Slide a nut over the end of the tube



B. Push the tube onto the connector as far as possible



C. Feed the nut up to the connector, fully tighten by hand and finally tighten one additional turn using spanners

CUTTING

To achieve good sealing and air-tight fitting of tube ends to their connecting parts, it is very important to cut tubing cleanly and squarely. A dedicated guillotine action tubing cutter is recommended, or a craft knife if such a tool is not available. Do not use electrician's side cutters.



A dedicated tubing cutter
RECOMMENDED



Electrician's Side Cutters
NOT RECOMMENDED

ROUTING

Study the underside of the vehicle and decide how to route each branch of the air circuit.

- To minimise the risk of chafing, avoid running tubing over metal edges as much as possible
- Avoid close proximity to heat sources such as the exhaust assembly
- Choose a route that provides as much protection as possible from dirt, debris and any solid objects that may impact the underside of the vehicle

> It is recommended that tubes are guided alongside brake lines as much as possible.

Use cable ties ('tie wraps') to secure tubing to the chassis, taking care not to over-tighten them.

5.7 BELLOW INFLATION

Once installation of the air assist kit is complete, inflate the air bellow to achieve the desired ride height via the inflator console taking careful note of the following.

ONCE THE INSTALLATION OF THE AIR ASSIST KIT IS COMPLETE:

- Inflate the air bellows to achieve the desired ride height via the inflator console.
- To achieve a correct ride height, the rear of the vehicle is approximately 6 cm higher than the front of the vehicle. That will correspond with a bellow height between 13 cm and 15 cm.
- The correct used pressure is up to the discretion of the installer, but is mostly between the 1.5 bar and the 4.5 bar.
- The pressure for driving your vehicle is depending on the weight of the vehicle and the condition of the original springs.
- Always keep in mind that you are using air assist suspension, that means helper springs, they are designed to help. Do not let them take over the original springs.
- Because our system is independent between the left and the right side, it is not a problem to inflate one side more to achieve the same height on the left and also on the right side.
- Once you know the pressure on your left and on your right side, make good notice of it, so you can check the pressure of your system every time you start driving.
- The note here below is for extreme situations.

IMPORTANT: Maximum and Minimum Pressure

MAXIMUM PRESSURE 7.0 BAR
MINIMUM PRESSURE 0.5 BAR

Do not exceed 7.0 bar (100 psi), which is the recommended maximum charge pressure for the air springs. The springs may be deflated if the vehicle is to be stored for a **lengthy period without use, but a pressure of at least 0.5 bar (7 psi) should be maintained at all times in order to avoid possible compression damage to the springs.**



5.8 SPRING ALIGNMENT

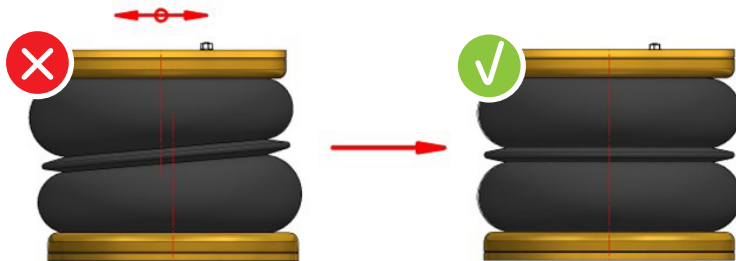

1. With the vehicle standing at the desired ride height, ensure that the springs are correctly aligned as illustrated above and then tighten the bolts to secure the bellow to both the upper and the lower mounting brackets.
2. Always check if the air bellow won't touch any obstacle

5.9 MAINTENANCE

Following installation, it is recommended that all metal parts are coated with a protective substance such as body wax.

The system does not require very much maintenance other than...

1. To maintain air pressure in the springs. Much like a tyre, the system may lose a little air over time.
2. To keep the air bellows clean. It is suggested that, when washing the vehicle, the bellows are inspected and cleaned as necessary (preferable by spraying). Look in particular for stones or grit trapped between convolutes, as this may damage the bellow.
3. Check before and after the winter period the wax coating. Re-wax when necessarily



5.10 CHECK LIST

Before driving the vehicle following completion of installation of the auxiliary air suspension system, please check:

- All bolts tightened to the recommended torque (Page 8)?
- Air springs set in alignment (Section 5.8)?
- Enough free space around the air springs to avoid wearing?
- All metal parts wax coated (Section 5.9)?
- Manufacturer's declaration form completed and a copy returned?



A wait of 24 hours is recommended in order to ensure that the vehicle has maintained its stance and that there are no air leaks present.



6 INSTALLATION PICTURES

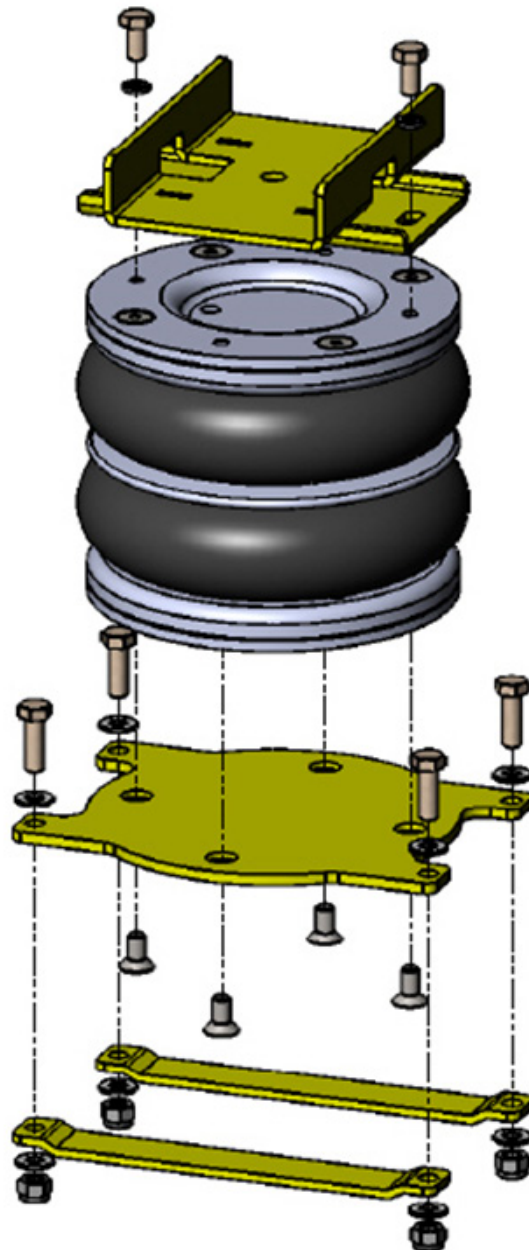

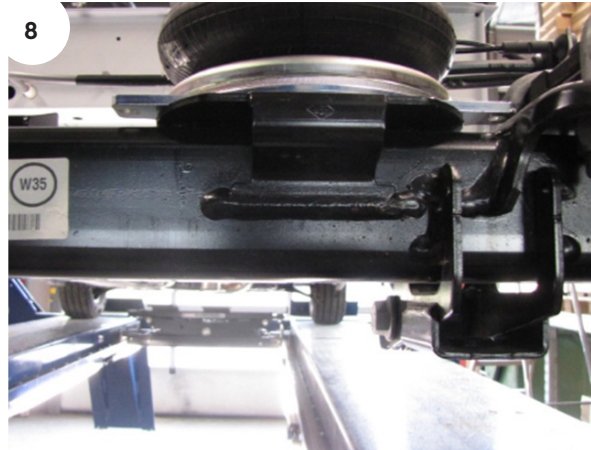
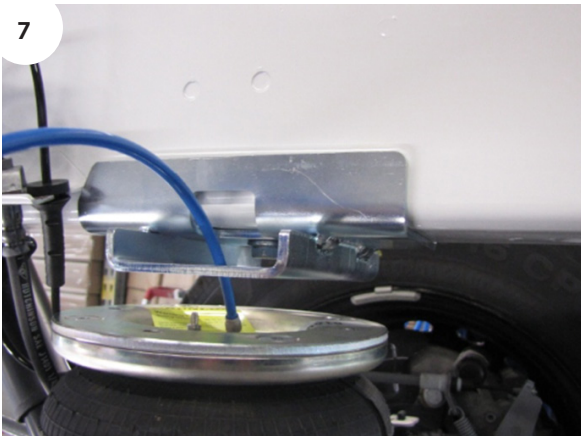
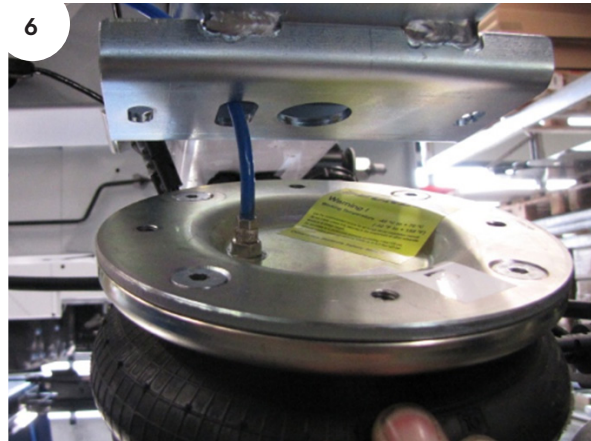

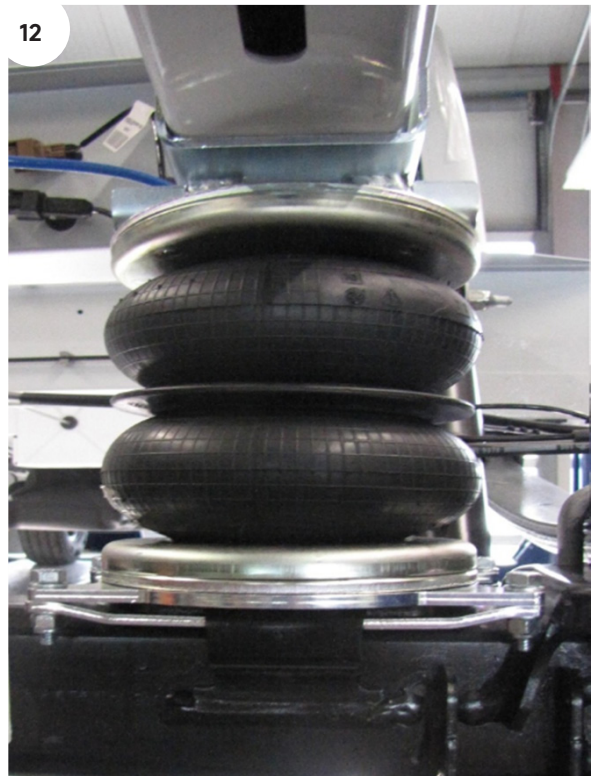
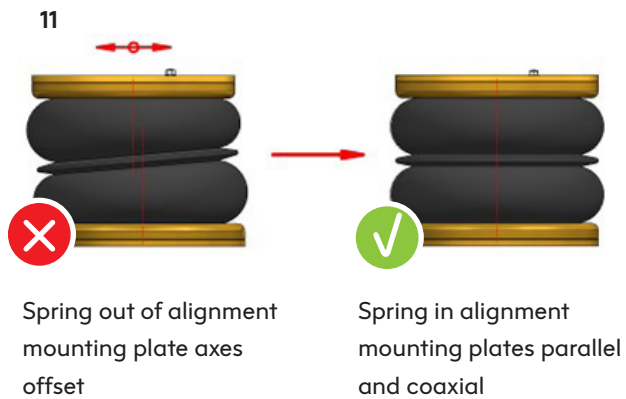

CAUTION! - Before fully tightening the bolts that secure the air spring to the upper and lower brackets, set the vehicle at ride height (spring height approximately 13..14 cm) and ensure that the springs are correctly aligned.



7 EPILOGUE

DSC Nederland hopes that you enjoy the benefits that your DUNLOP air suspension system will provide for you. To ensure optimal performance, we advise that you have your system checked frequently by qualified personnel. As recommended in the fitting instructions, it is important to coat all the steel parts with a protective substance such as body wax.

IMPORTANT: Manufacturer's Declaration Form

A manufacturer's declaration form is provided with your kit. Following installation of the kit please ensure that this form is completed, signed by a qualified fitter and a copy is returned to DSC Nederland by post, fax or e-mail. Our e-mail address is:

info@dscsystems.nl

As a condition of your warranty, modifications to the system may only be carried out by personnel of DSC Nederland.

ENQUIRIES

For general enquiries please contact one of our dealers. You can find them on our website.

WWW.DSCSYSTEMS.NL





DUNLOP and the Flying D device are trademarks of Sumitomo Rubber Group and are used under license by DSC Nederland B.V.

DSC Nederland B.V.

Het Wegdam 22
7496 CA Hengevelde
Nederland

T +31 (0)547 333 065

F +31 (0)547 333 068

E info@dscsystems.nl

W www.dscsystems.nl